

Varenummer: 23052102412
 Beskrivelse: E+G Håndsving
 EKH.100-A12-C2, orange dækkappe

Mål

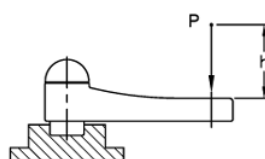

$$L[J] = P[N] \cdot h[m]$$

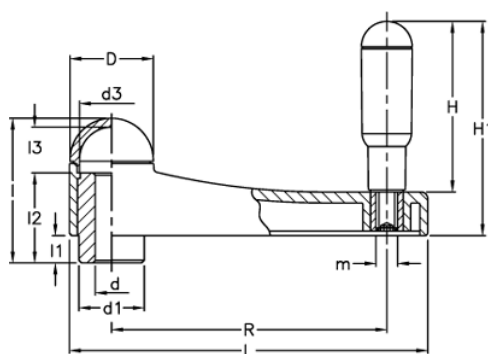
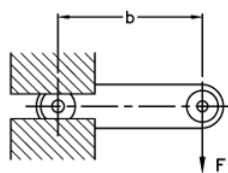

$$C[N \cdot m] = F[N] \cdot b[m]$$

C (N*m) = 200	L = 131.5
d = 30.5	L (J) = 27
d1 = 24	l1 = 10
d3 = 23.5	l2 = 33
d H7 = 12	l3 = 17
H = 73	m = M8
H1 = 89.0	R = 101
l = 52.5	